

Model: D4DH-250 X

Data

Type: Semi-hermetic piston compressors

Producer: Copeland

Series: DISCUS

Model: D4DH-250 X

Technical data

Cylinder count:	4
Displacement [m ³ /h]:	70,8
Weight [kg]:	225
Oil charge [dm ³]:	4
Max. operating current [A]:	41,5
Locked rotor current [A]:	192
Power supply [V/~/Hz]:	380-420V/3/50Hz

Connections

	<u>milimeters</u>	<u>inches</u>
Suction line:		2 1/8"
Discharge line:		1 1/8"

Model: D4DH-250 X

Capacity

R22

Cooling capacity [kW]

$t_c \setminus t_e$	-25	-20	-15	-10	-5	0	5	10
30	23.23	29.14	36.07	44.16	53.58	64.48	77.01	91.33
35	21.72	27.45	34.11	41.87	50.86	61.26	73.21	86.87
40	20.20	25.74	32.13	39.53	48.10	57.99	69.35	82.35
45	-	24.00	30.12	37.16	45.30	54.67	65.44	77.77
50	-	22.26	28.08	34.77	42.46	51.31	61.49	73.14
55	-	-	26.04	32.35	39.59	47.92	57.49	68.45
60	-	-	23.98	29.92	36.71	44.50	53.46	63.73

Power input [kW]

$t_c \setminus t_e$	-25	-20	-15	-10	-5	0	5	10
30	9.17	10.06	10.88	11.57	12.10	12.43	12.52	12.33
35	9.72	10.74	11.70	12.55	13.26	13.80	14.11	14.17
40	10.24	11.38	12.48	13.49	14.38	15.11	15.64	15.93
45	-	11.99	13.22	14.38	15.44	16.36	17.10	17.62
50	-	12.58	13.93	15.23	16.45	17.55	18.49	19.23
55	-	-	14.60	16.03	17.41	18.69	19.82	20.78
60	-	-	15.23	16.80	18.32	19.76	21.09	22.25

Model: D4DH-250 X

Capacity

Current [A]

t_c \ t_e	-25	-20	-15	-10	-5	0	5	10
30	20.64	21.82	22.90	23.84	24.57	25.03	25.15	24.88
35	21.36	22.71	24.01	25.18	26.18	26.93	27.38	27.46
40	22.05	23.58	25.08	26.49	27.74	28.78	29.55	29.97
45	-	24.42	26.12	27.75	29.26	30.58	31.65	32.41
50	-	25.23	27.12	28.97	30.72	32.31	33.69	34.78
55	-	-	28.06	30.13	32.12	33.98	35.65	37.06
60	-	-	28.96	31.22	33.45	35.57	37.52	39.25

Mass flow [kg/s]

t_c \ t_e	-25	-20	-15	-10	-5	0	5	10
30	442.47	560.18	696.38	855.95	1 043.77	1 264.71	1 523.65	1 825.46
35	428.75	546.18	681.68	840.12	1 026.39	1 245.35	1 501.89	1 800.87
40	414.23	531.18	665.78	822.90	1 007.42	1 224.20	1 478.14	1 774.10
45	-	515.27	648.77	804.37	986.93	1 201.35	1 452.48	1 745.21
50	-	498.52	630.72	784.59	965.01	1 176.85	1 424.99	1 714.30
55	-	-	611.71	763.66	941.73	1 150.80	1 395.75	1 681.44
60	-	-	591.81	741.64	917.17	1 123.27	1 364.82	1 646.69

Model: D4DH-250 X

Capacity

C.O.P. [W/W]

$t_c \setminus t_e$	-25	-20	-15	-10	-5	0	5	10
30	2.53	2.90	3.32	3.82	4.43	5.19	6.15	7.40
35	2.24	2.56	2.92	3.34	3.83	4.44	5.19	6.13
40	1.97	2.26	2.58	2.93	3.35	3.84	4.44	5.17
45	-	2.00	2.28	2.58	2.93	3.34	3.83	4.41
50	-	1.77	2.02	2.28	2.58	2.92	3.33	3.80
55	-	-	1.78	2.02	2.27	2.56	2.90	3.29
60	-	-	1.57	1.78	2.00	2.25	2.54	2.86

Application range

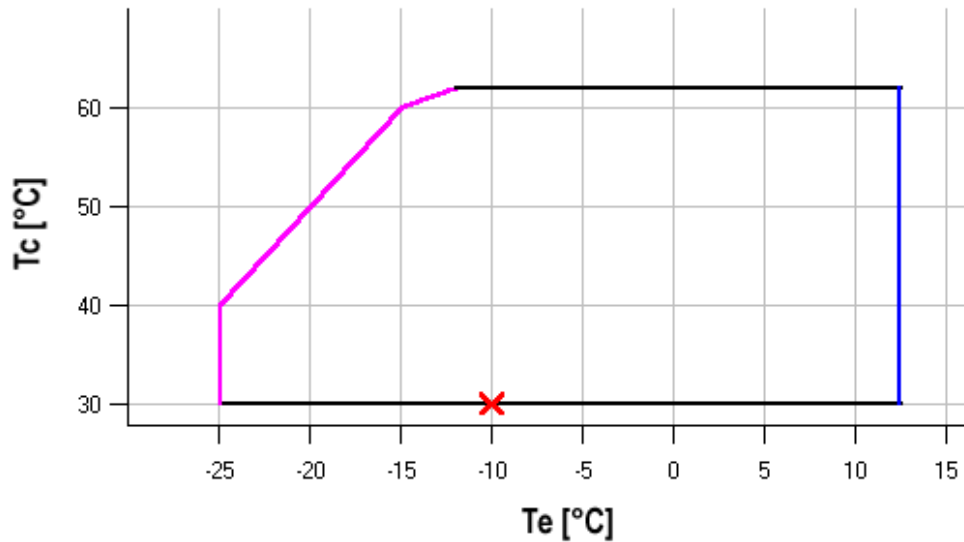

- Maximum evaporating temperature
- 25°C suction gas return

Operating conditions: ISO; subcooling: 0 K, suction superheat: 10 K, return gas temperature: -
 t_c - Condensing temperature [°C]
 t_e - Evaporating temperature [°C]

Model: D4DH-250 X

Capacity

R134a

Cooling capacity [kW]

t_c \ t_e	-20	-15	-10	-5	0	5	10	15	20	25
40	15.84	19.90	24.79	30.66	37.64	45.86	55.45	66.54	-	-
45	14.37	18.33	23.05	28.65	35.26	43.02	52.05	62.50	74.48	88.14
50	12.94	16.81	21.33	26.65	32.88	40.17	48.64	58.43	69.66	82.47
55	11.55	15.31	19.64	24.66	30.50	37.31	45.20	54.32	64.79	76.75
60	-	13.85	17.97	22.68	28.12	34.43	41.74	50.18	59.87	70.96
65	-	12.43	16.31	20.71	25.74	31.55	38.25	46.00	54.91	65.12
70	-	-	14.68	18.75	23.36	28.64	34.74	41.78	49.89	59.21
75	-	-	-	16.79	20.97	25.73	31.20	37.53	44.83	-
80	-	-	-	14.84	18.57	22.79	27.63	33.23	-	-

Power input [kW]

t_c \ t_e	-20	-15	-10	-5	0	5	10	15	20	25
40	6.89	7.72	8.53	9.28	9.95	10.50	10.89	11.11	-	-
45	7.14	8.06	8.97	9.85	10.65	11.36	11.93	12.35	12.56	12.56
50	7.37	8.38	9.39	10.38	11.32	12.18	12.93	13.53	13.95	14.17
55	7.59	8.67	9.78	10.88	11.95	12.95	13.86	14.65	15.28	15.72
60	-	8.94	10.13	11.34	12.53	13.67	14.74	15.71	16.53	17.18
65	-	9.17	10.45	11.75	13.06	14.34	15.56	16.70	17.71	18.57
70	-	-	10.72	12.12	13.54	14.95	16.32	17.62	18.81	19.87
75	-	-	-	12.43	13.96	15.49	17.00	18.46	19.83	-
80	-	-	-	12.69	14.32	15.97	17.61	19.22	-	-

Model: D4DH-250 X

Capacity

Current [A]

t_c \ t_e	-20	-15	-10	-5	0	5	10	15	20	25
40	16.99	17.94	18.88	19.78	20.58	21.24	21.71	21.94	-	-
45	17.35	18.37	19.42	20.46	21.43	22.31	23.02	23.53	23.80	23.76
50	17.68	18.76	19.92	21.10	22.25	23.33	24.29	25.09	25.66	25.98
55	17.96	19.12	20.38	21.70	23.03	24.32	25.52	26.59	27.48	28.15
60	-	19.43	20.80	22.26	23.76	25.26	26.70	28.05	29.26	30.27
65	-	19.70	21.17	22.76	24.44	26.15	27.84	29.46	30.98	32.33
70	-	-	21.49	23.22	25.07	26.98	28.91	30.82	32.64	34.35
75	-	-	-	23.62	25.64	27.76	29.93	32.11	34.25	-
80	-	-	-	23.97	26.16	28.48	30.89	33.35	-	-

Mass flow [kg/s]

t_c \ t_e	-20	-15	-10	-5	0	5	10	15	20	25
40	287.08	409.97	539.93	684.10	849.64	1 043.69	1 273.40	1 545.93	-	-
45	275.90	398.72	528.26	671.68	836.13	1 028.75	1 256.70	1 527.13	1 847.18	2 224.01
50	264.75	387.22	516.09	658.49	821.58	1 012.52	1 238.44	1 506.50	1 823.85	2 197.63
55	253.74	375.60	503.52	644.65	806.12	995.10	1 218.73	1 484.16	1 798.54	2 169.02
60	-	363.96	490.68	630.25	789.85	976.60	1 197.67	1 460.21	1 771.36	2 138.27
65	-	352.41	477.65	615.42	772.86	957.14	1 175.38	1 434.76	1 742.41	2 105.49
70	-	-	464.56	600.25	755.29	936.81	1 151.97	1 407.92	1 711.81	2 070.79
75	-	-	-	584.86	737.22	915.73	1 127.54	1 379.80	1 679.67	-
80	-	-	-	569.35	718.77	894.00	1 102.20	1 350.51	-	-

Model: D4DH-250 X

Capacity

C.O.P. [W/W]

$t_c \setminus t_e$	-20	-15	-10	-5	0	5	10	15	20	25
40	2.30	2.58	2.91	3.30	3.78	4.37	5.09	5.99	-	-
45	2.01	2.27	2.57	2.91	3.31	3.79	4.36	5.06	5.93	7.02
50	1.75	2.01	2.27	2.57	2.90	3.30	3.76	4.32	4.99	5.82
55	1.52	1.77	2.01	2.27	2.55	2.88	3.26	3.71	4.24	4.88
60	-	1.55	1.77	2.00	2.24	2.52	2.83	3.19	3.62	4.13
65	-	1.35	1.56	1.76	1.97	2.20	2.46	2.75	3.10	3.51
70	-	-	1.37	1.55	1.73	1.92	2.13	2.37	2.65	2.98
75	-	-	-	1.35	1.50	1.66	1.84	2.03	2.26	-
80	-	-	-	1.17	1.30	1.43	1.57	1.73	-	-

Application range

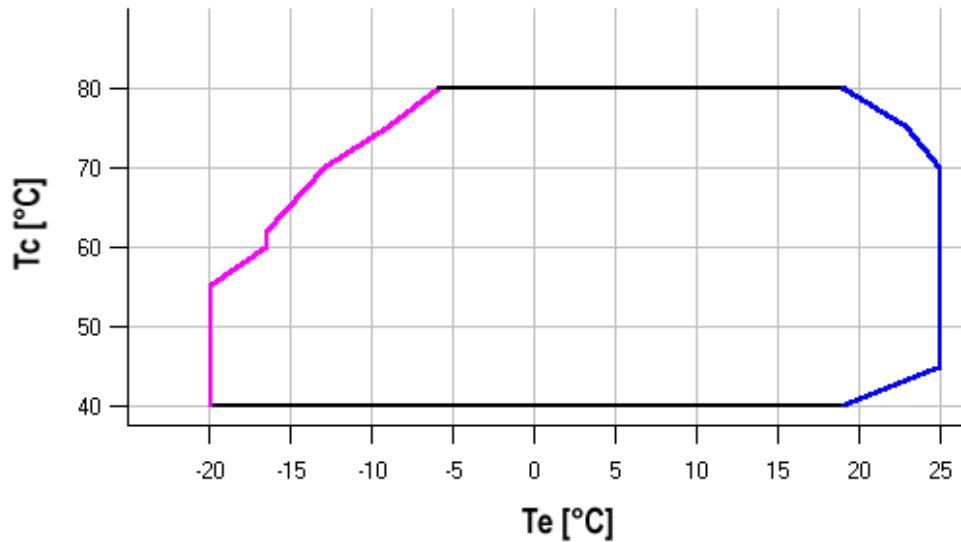

 Maximum evaporating temperature

 20K suction superheat

Operating conditions: ISO; subcooling: 0 K, suction superheat: 10 K, return gas temperature: -

t_c - Condensing temperature [°C]

t_e - Evaporating temperature [°C]

Model: D4DH-250 X

Capacity

R404A/R507

Cooling capacity [kW]

$t_c \setminus t_e$	-35	-30	-25	-20	-15	-10	-5	0	5
20	17.88	23.14	29.45	36.91	45.64	55.76	67.39	80.64	95.63
25	16.33	21.36	27.34	34.41	42.66	52.23	63.22	75.76	89.97
30	14.79	19.56	25.22	31.87	39.64	48.64	59.00	70.82	84.23
35	13.25	17.76	23.07	29.31	36.58	45.02	54.72	65.82	78.42
40	-	15.95	20.91	26.72	33.49	41.34	50.39	60.75	72.54
45	-	14.13	18.74	24.12	30.37	37.63	46.01	55.62	66.59
50	-	12.32	16.56	21.49	27.23	33.89	41.58	50.44	60.57
55	-	10.51	14.38	18.85	24.06	30.11	37.12	45.21	54.50

Power input [kW]

$t_c \setminus t_e$	-35	-30	-25	-20	-15	-10	-5	0	5
20	7.85	8.82	9.72	10.50	11.08	11.39	11.38	10.97	10.11
25	8.06	9.18	10.26	11.24	12.05	12.64	12.93	12.86	12.36
30	8.20	9.44	10.69	11.86	12.90	13.75	14.33	14.57	14.43
35	8.26	9.62	11.02	12.37	13.63	14.72	15.57	16.13	16.33
40	-	9.72	11.25	12.78	14.24	15.56	16.68	17.54	18.06
45	-	9.75	11.41	13.09	14.74	16.28	17.65	18.79	19.63
50	-	9.71	11.48	13.31	15.13	16.88	18.50	19.91	21.06
55	-	9.62	11.48	13.44	15.43	17.38	19.22	20.89	22.33

Model: D4DH-250 X

Capacity

Current [A]

$t_c \setminus t_e$	-35	-30	-25	-20	-15	-10	-5	0	5
20	18.63	19.61	20.61	21.54	22.29	22.77	22.87	22.50	21.56
25	18.89	20.04	21.24	22.40	23.42	24.20	24.64	24.65	24.11
30	19.08	20.38	21.78	23.18	24.47	25.55	26.33	26.71	26.59
35	19.18	20.65	22.25	23.87	25.43	26.82	27.94	28.70	28.98
40	-	20.83	22.63	24.49	26.32	28.01	29.47	30.60	31.29
45	-	20.94	22.93	25.02	27.12	29.12	30.92	32.42	33.52
50	-	20.96	23.15	25.48	27.84	30.14	32.28	34.16	35.67
55	-	20.90	23.29	25.85	28.48	31.09	33.56	35.81	37.74

Mass flow [kg/s]

$t_c \setminus t_e$	-35	-30	-25	-20	-15	-10	-5	0	5
20	385.49	511.33	656.00	825.10	1 024.19	1 258.88	1 534.74	1 857.35	2 232.30
25	372.95	496.40	638.94	806.16	1 003.64	1 236.97	1 511.73	1 833.50	2 207.87
30	357.71	478.91	619.46	784.95	980.96	1 213.08	1 486.88	1 807.96	2 181.89
35	340.01	459.11	597.82	761.73	956.41	1 187.46	1 460.46	1 780.98	2 154.62
40	-	437.26	574.27	736.74	930.25	1 160.37	1 432.71	1 752.83	2 126.32
45	-	413.61	549.07	710.25	902.72	1 132.07	1 403.89	1 723.75	2 097.25
50	-	388.42	522.48	682.51	874.09	1 102.81	1 374.25	1 694.00	2 067.64
55	-	361.94	494.74	653.77	844.61	1 072.85	1 344.06	1 663.84	2 037.77

Model: D4DH-250 X



Capacity

C.O.P. [W/W]

$t_c \setminus t_e$	-35	-30	-25	-20	-15	-10	-5	0	5
20	2.28	2.62	3.03	3.52	4.12	4.89	5.92	7.35	9.46
25	2.03	2.33	2.67	3.06	3.54	4.13	4.89	5.89	7.28
30	1.80	2.07	2.36	2.69	3.07	3.54	4.12	4.86	5.84
35	1.60	1.85	2.09	2.37	2.68	3.06	3.51	4.08	4.80
40	-	1.64	1.86	2.09	2.35	2.66	3.02	3.46	4.02
45	-	1.45	1.64	1.84	2.06	2.31	2.61	2.96	3.39
50	-	1.27	1.44	1.61	1.80	2.01	2.25	2.53	2.88
55	-	1.09	1.25	1.40	1.56	1.73	1.93	2.16	2.44

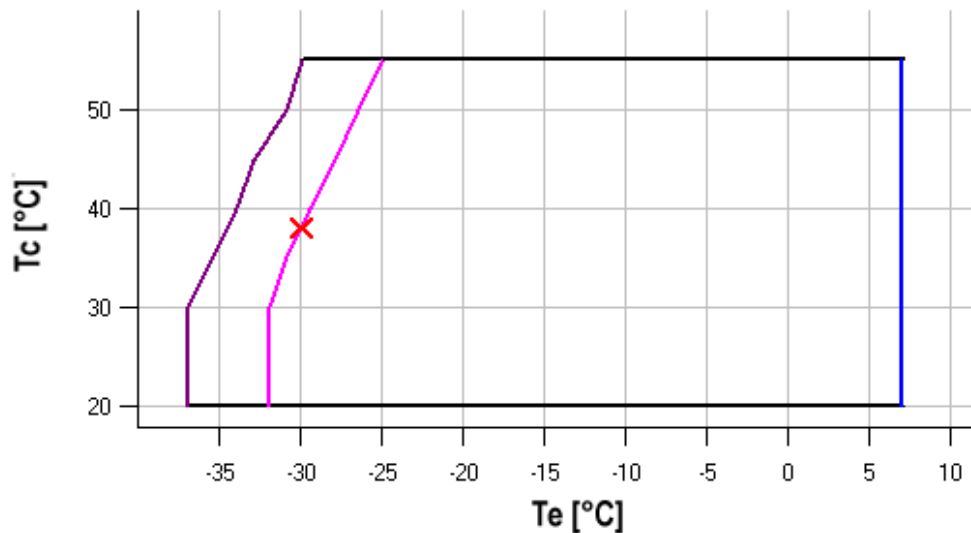
Application range



-  Maximum evaporating temperature
-  25°C suction gas return
-  25°C suction gas return + additional cooling

Operating conditions: ISO; subcooling: 0 K, suction superheat: - K, return gas temperature: 20

t_c - Condensing temperature [°C]

t_e - Evaporating temperature [°C]

Model: D4DH-250 X

Capacity

R407C

Cooling capacity [kW]

$t_c \setminus t_e$	-20	-15	-10	-5	0	5	10	15
35	23.38	29.62	37.49	46.94	57.91	70.33	84.14	-
40	21.66	27.44	34.83	43.77	54.18	66.02	79.22	-
45	19.78	25.10	32.00	40.42	50.28	61.54	74.12	-
50	-	22.55	28.95	36.84	46.15	56.82	68.77	-
55	-	19.72	25.63	32.99	41.73	51.80	63.13	-
60	-	-	21.96	28.79	36.97	46.44	57.14	-

Power input [kW]

$t_c \setminus t_e$	-20	-15	-10	-5	0	5	10	15
35	10.16	10.87	11.64	12.38	13.02	13.47	13.66	-
40	10.92	11.73	12.63	13.52	14.35	15.02	15.45	-
45	11.56	12.46	13.48	14.54	15.55	16.43	17.10	-
50	-	13.03	14.17	15.38	16.57	17.66	18.58	-
55	-	13.38	14.64	16.01	17.38	18.69	19.84	-
60	-	-	14.87	16.38	17.94	19.45	20.85	-

Model: D4DH-250 X

Capacity

Current [A]

$t_c \setminus t_e$	-20	-15	-10	-5	0	5	10	15
35	22.04	22.95	23.96	24.96	25.83	26.45	26.71	-
40	23.03	24.07	25.27	26.51	27.65	28.60	29.22	-
45	23.87	25.06	26.45	27.92	29.35	30.62	31.61	-
50	-	25.84	27.42	29.12	30.84	32.44	33.80	-
55	-	26.31	28.09	30.04	32.04	33.97	35.72	-
60	-	-	28.39	30.58	32.87	35.14	37.27	-

Mass flow [kg/s]

$t_c \setminus t_e$	-20	-15	-10	-5	0	5	10	15
35	516.34	642.65	799.66	985.08	1 196.60	1 431.94	1 688.79	-
40	503.89	626.72	780.91	964.17	1 174.21	1 408.71	1 665.40	-
45	485.73	605.46	757.21	938.70	1 147.62	1 381.68	1 638.59	-
50	-	576.35	726.05	906.14	1 114.34	1 348.33	1 605.84	-
55	-	536.88	684.91	863.99	1 071.84	1 306.16	1 564.64	-
60	-	-	631.28	809.74	1 017.62	1 252.63	1 512.48	-

Model: D4DH-250 X

Capacity

C.O.P. [W/W]

$t_c \setminus t_e$	-20	-15	-10	-5	0	5	10	15
35	2.30	2.72	3.22	3.79	4.45	5.22	6.16	-
40	1.98	2.34	2.76	3.24	3.78	4.40	5.13	-
45	1.71	2.01	2.37	2.78	3.23	3.75	4.33	-
50	-	1.73	2.04	2.40	2.79	3.22	3.70	-
55	-	1.47	1.75	2.06	2.40	2.77	3.18	-
60	-	-	1.48	1.76	2.06	2.39	2.74	-

Application range

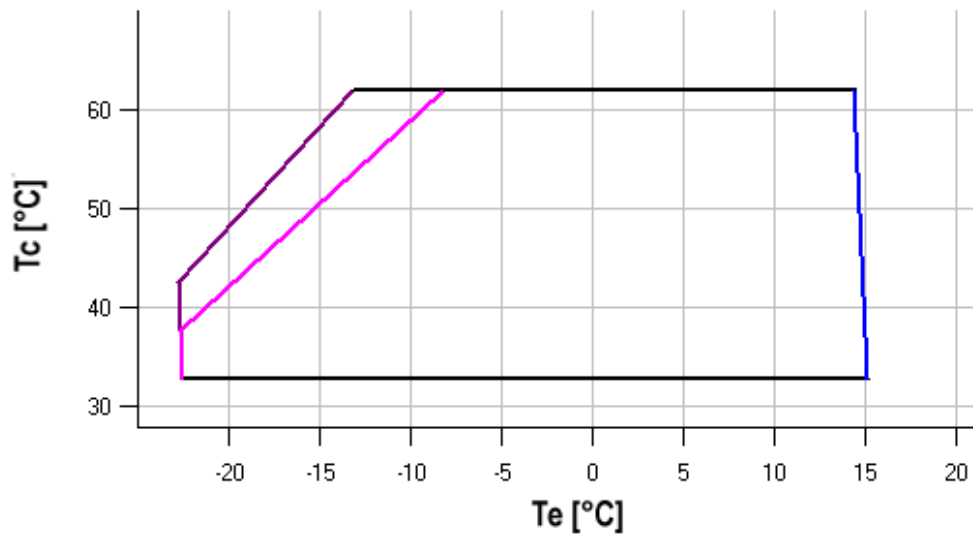

- █ Maximum evaporating temperature
- █ 25°C suction gas return
- █ 20K suction superheat

Operating conditions: ISO; subcooling: 0 K, suction superheat: 10 K, return gas temperature: -
 t_c - Condensing temperature [°C]
 t_e - Evaporating temperature [°C]

Model: D4DH-250 X

Dimensions

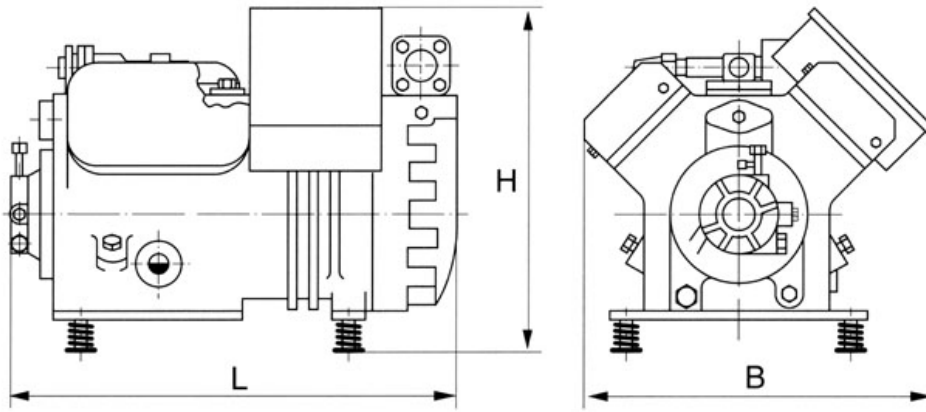

L	670 mm
B	535 mm
H	495 mm

Model: D4DH-250 X

Image

